

#13
W. L. Lauer
2/14/03

IN THE UNITED STATES PATENT AND TRADEMARK OFFICE

Applicant : Robert M. COOPER, et al. Art Unit : 2611
Serial No. : 09/365,735 Examiner : Son Huynh
Filed : August 3, 1999
Title : VARYING ELECTRONIC CONTENT BASED ON LOCAL CONTEXT

Attention: Official Draftsman
Commissioner for Patents
Washington, D.C. 20231

TRANSMITTAL OF FORMAL DRAWINGS

Please substitute the enclosed eleven (11) sheets of formal drawings for the corresponding drawings presently in the application.

Please apply any charges or credits to Deposit Account No. 06-1050.

Respectfully submitted,

Date: February 3, 2003



Scott R. Boalick
Reg. No. 42,337

Fish & Richardson P.C.
1425 K Street, N.W.
11th Floor
Washington, DC 20005-3500
Telephone: (202) 783-5070
Facsimile: (202) 783-2331



Fig. 1
(PRIOR ART)

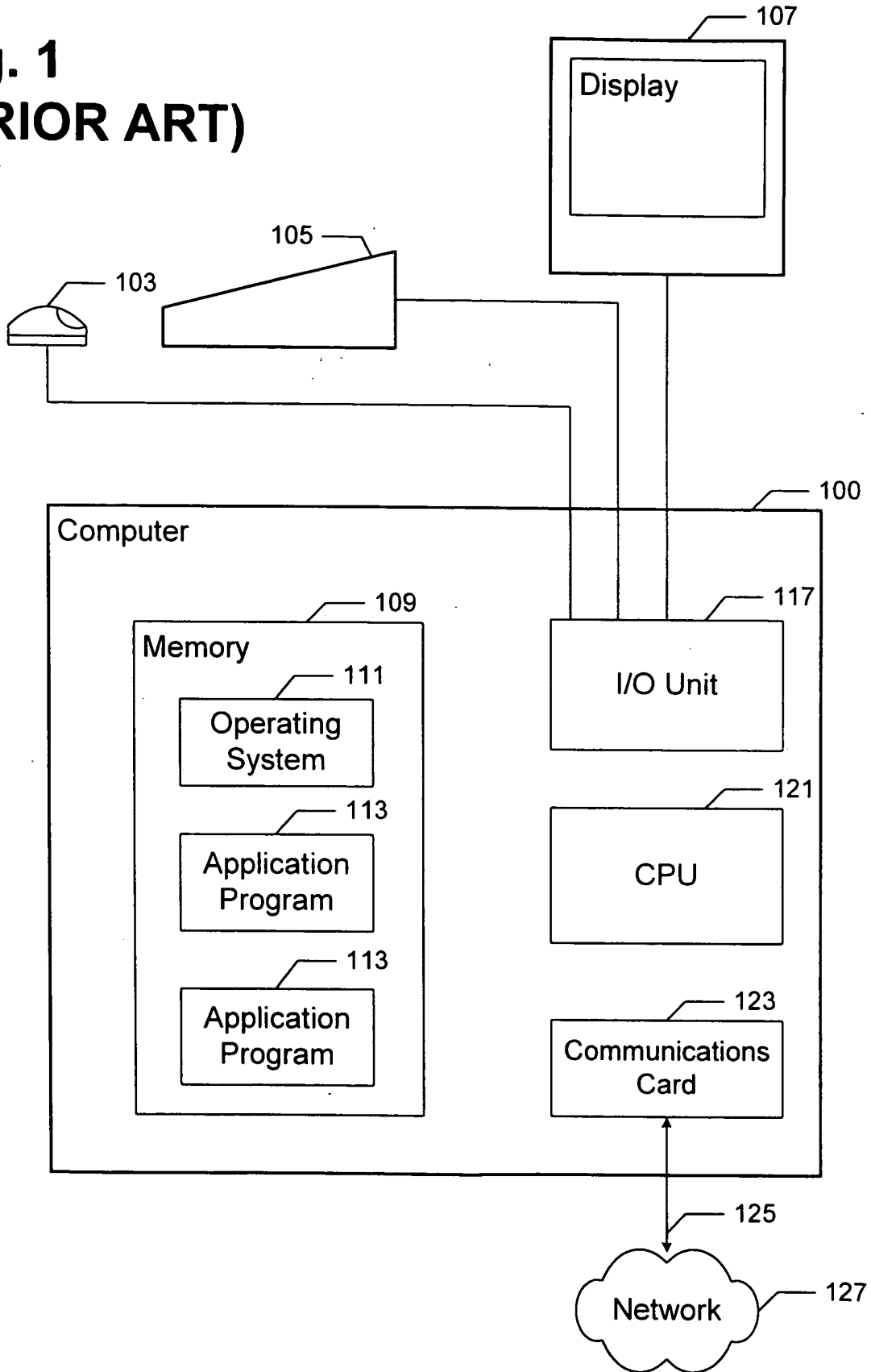

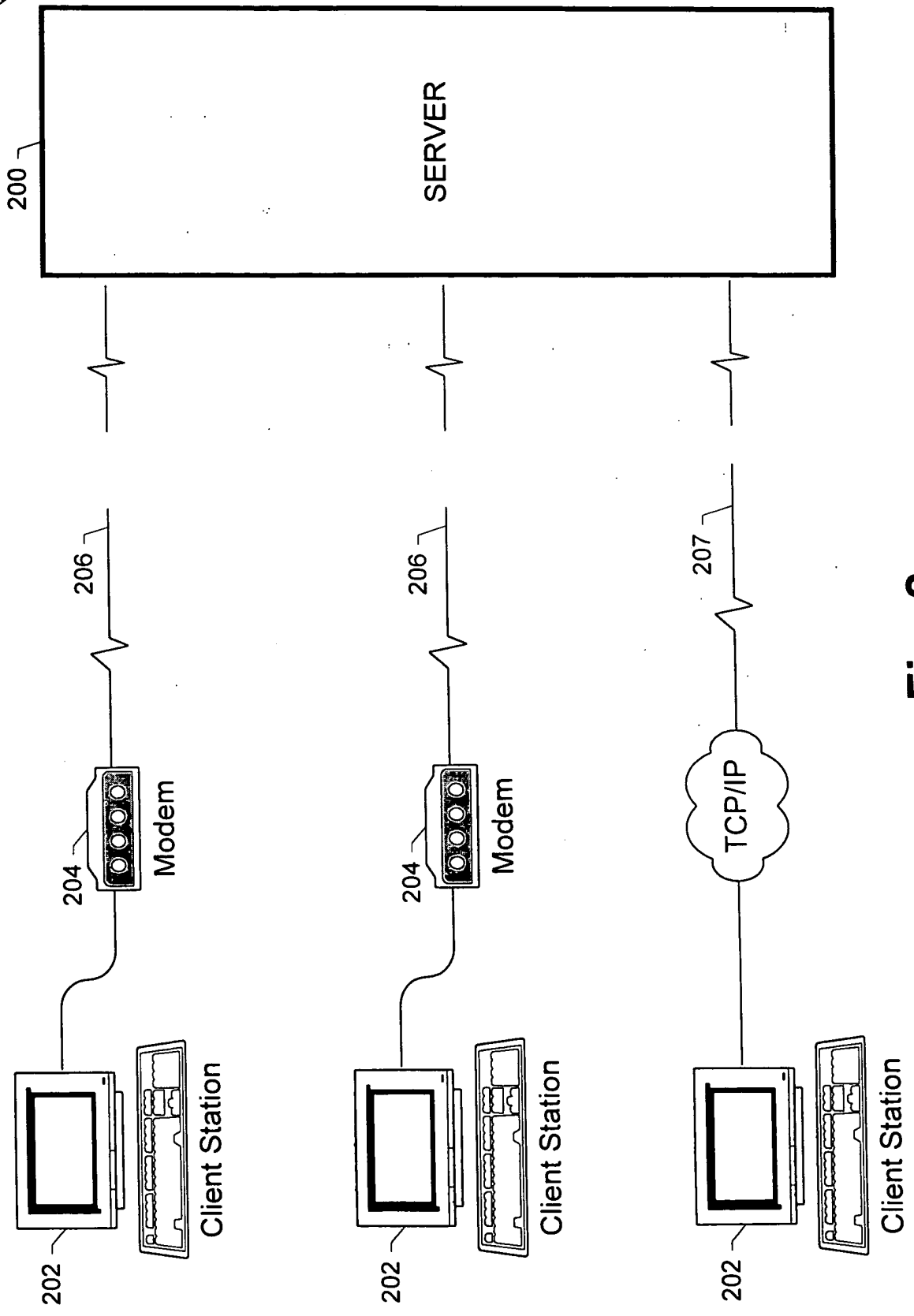
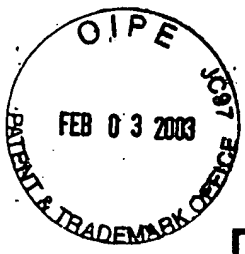

Fig. 2
(PRIOR ART)



300

SIO - Ship Operations and Marine Technical Support - Microsoft Internet Explorer

Address: http://sio.uced.edu/supp_groups/shipsked/index.html

302

304

SHIP OPERATIONS and Marine Technical Support
Scripps Institution of Oceanography, UCSD

304

SHIP DESCRIPTIONS, PHOTOS, DECK PLANS, HANDBOOKS
 R/V Roger Revelle R/V Melville R/P FLIP R/P FLIP
 R/V New Horizon R/V Robert Gordon Sprout Ship Handbooks
 GENERAL INFORMATION
 Shipboard Technical Support Nimitz Marine Facility
 SHIP SCHEDULING
 Schedules Forms Key Contacts General Info/News

306

[Revelle] [Melville] [New Horizon] [Sprout] [FLIP] [Ship Handbooks]
 [STS] [Marine Facility]
 [Schedules] [Forms] [Contacts] [General Info/News]

Other important ship-related links: [OCEANIC] [UNOLS]

Return to SCRIPPS INSTITUTION OF OCEANOGRAPHY

Fig. 3 (Prior Art)

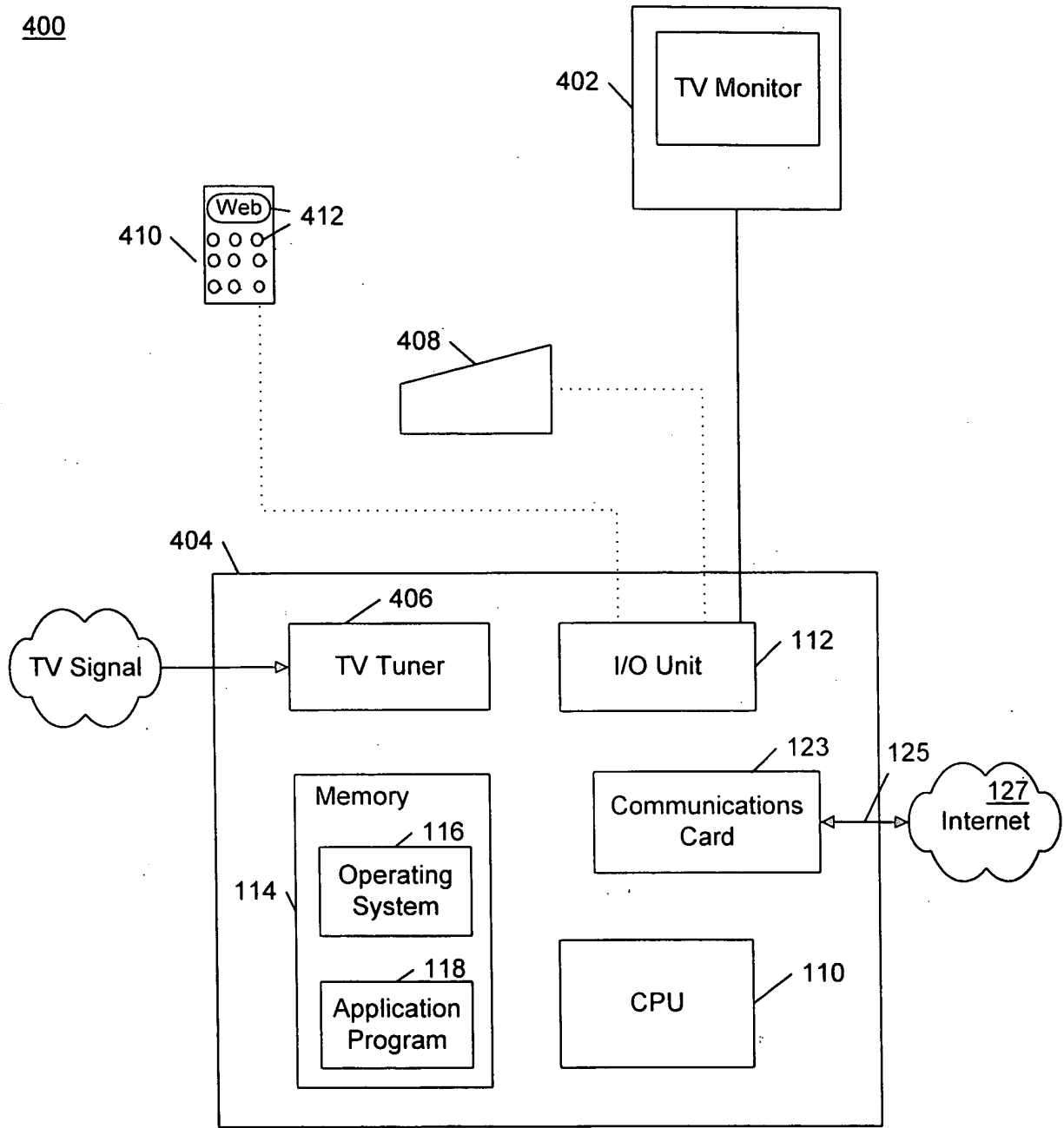

Fig. 4
(PRIOR ART)

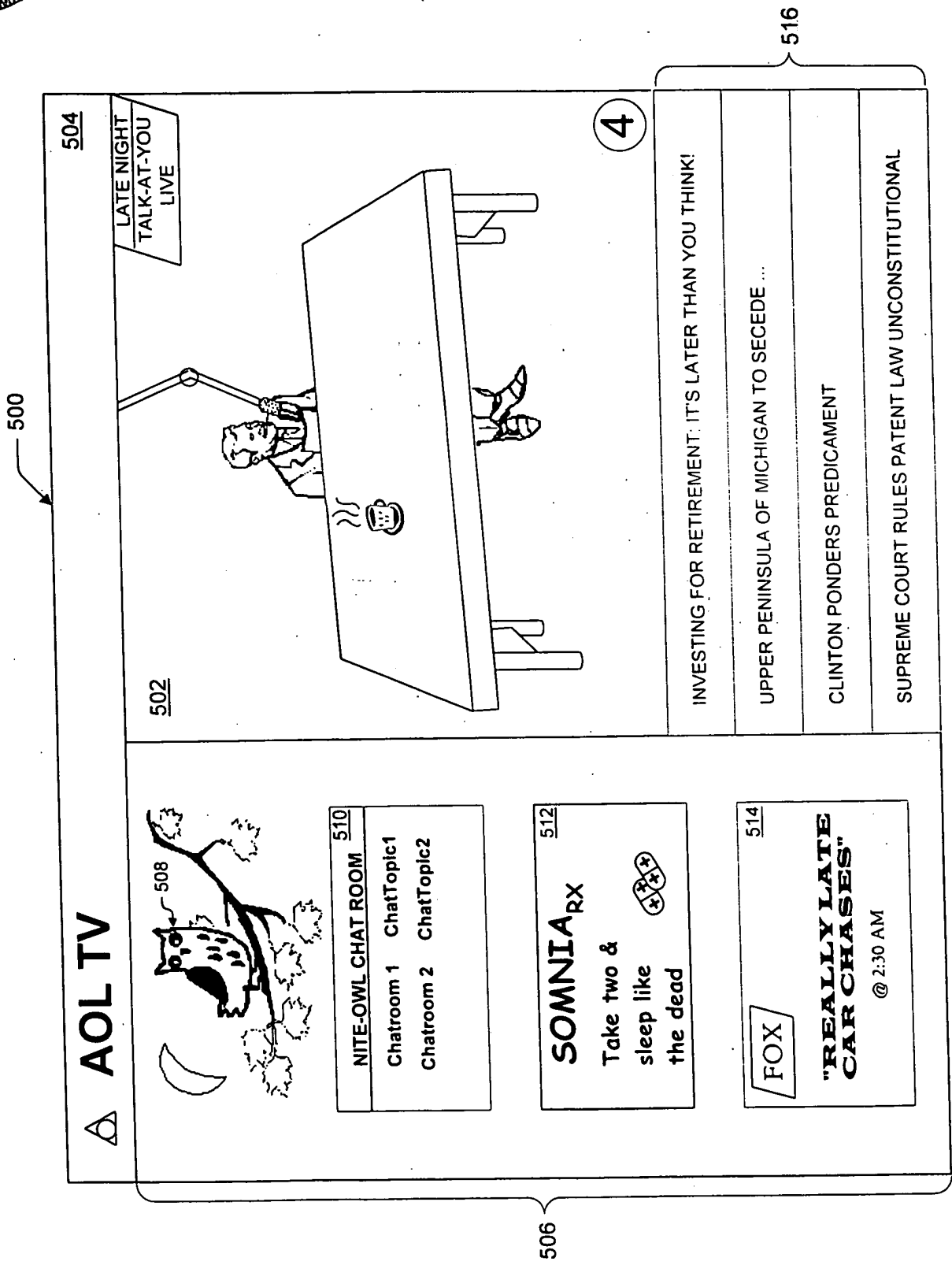

Fig. 5

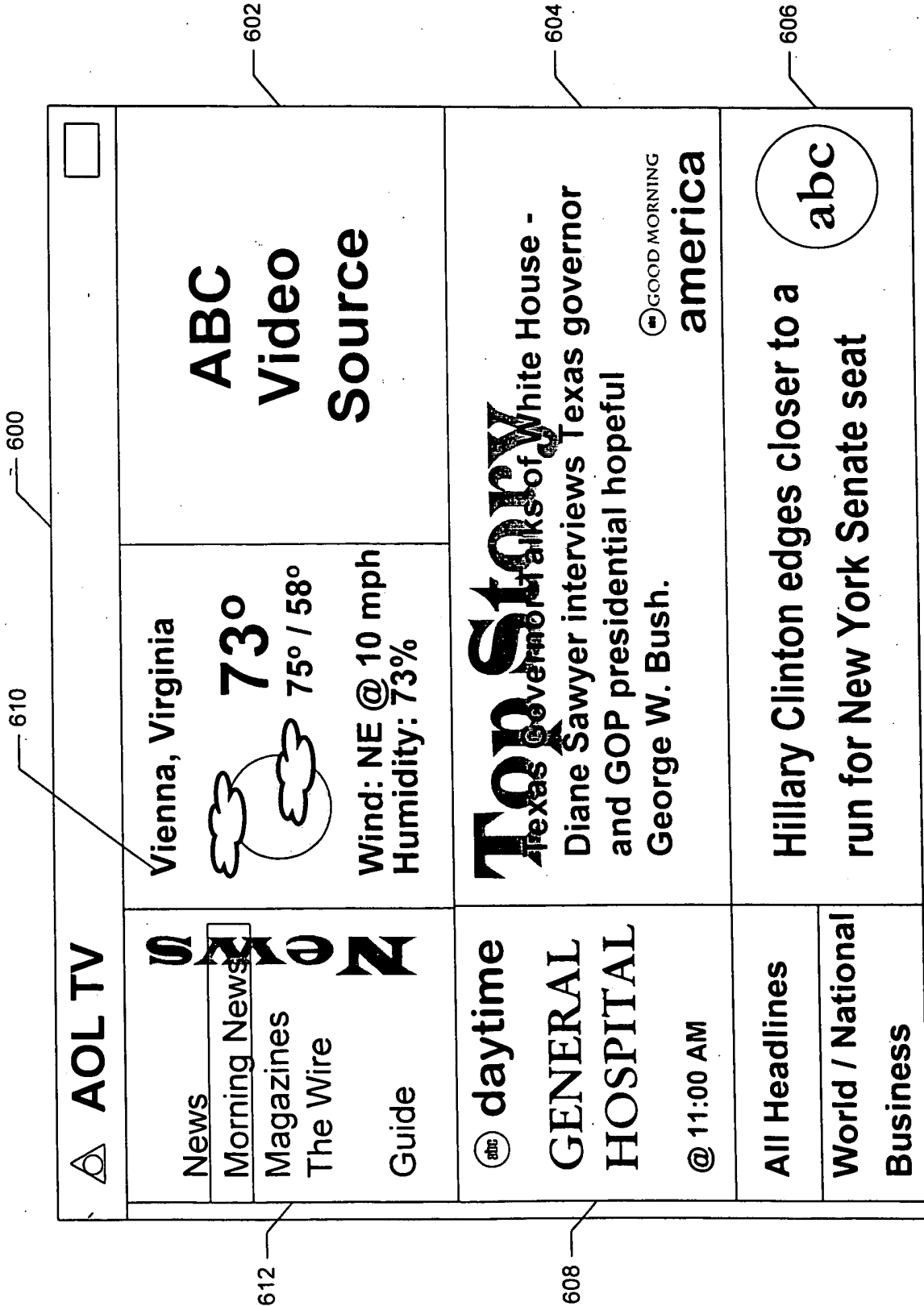

Fig. 6A



614





AOL TV		CBS Video Source
 News Morning News Magazines The Wire Guide	Vienna, Virginia  73° 75° / 58° Wind: NE @ 10 mph Humidity: 73%	
 JOAN OF ARC  Sunday @ 9pm	TOP STORY <small>On the eve of a youth violence summit,</small> Clinton voew not to let the entertainment industries become scapegoats.  CBS Evening News° Dan Rather	
All Headlines World / National Business	Hillary Clinton edges closer to a run for New York Senate seat 	

Fig. 6B



616

		<input type="checkbox"/>	
<p>News</p> <p>Morning News</p> <p>Magazines</p> <p>The Wire</p> <p>Guide</p>	<p>Vienna, Virginia</p> <p> 73°</p> <p>75° / 58°</p> <p>Wind: NE @ 10 mph</p> <p>Humidity: 73%</p>	<p>NBC</p> <p>Video</p> <p>Source</p>	
<p>THE Tonight</p> <p>SHOW</p> <p>WITH</p> <p>JAY LENO</p> <p>@ 11pm</p>	<p>Top Story</p> <p>Jones: We did something wrong'</p> <p>Talk show host says she, producers are not to blame for guest's slaying.</p>		
<p>All Headlines</p> <p>World / National</p> <p>Business</p>	<p>Hillary Clinton edges closer to a run for New York Senate seat</p>		

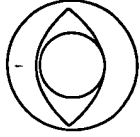
Fig. 6C

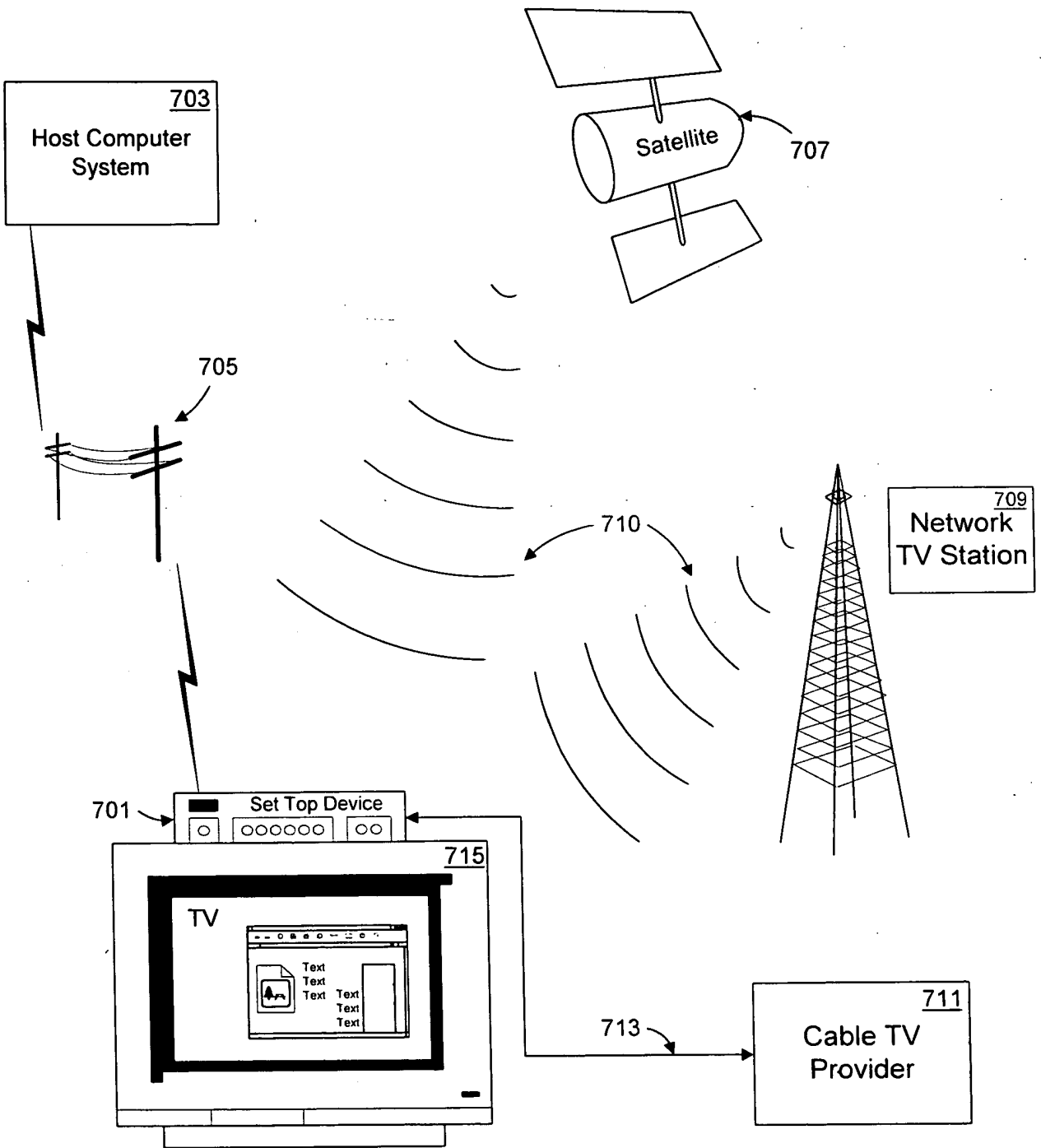

Fig. 7

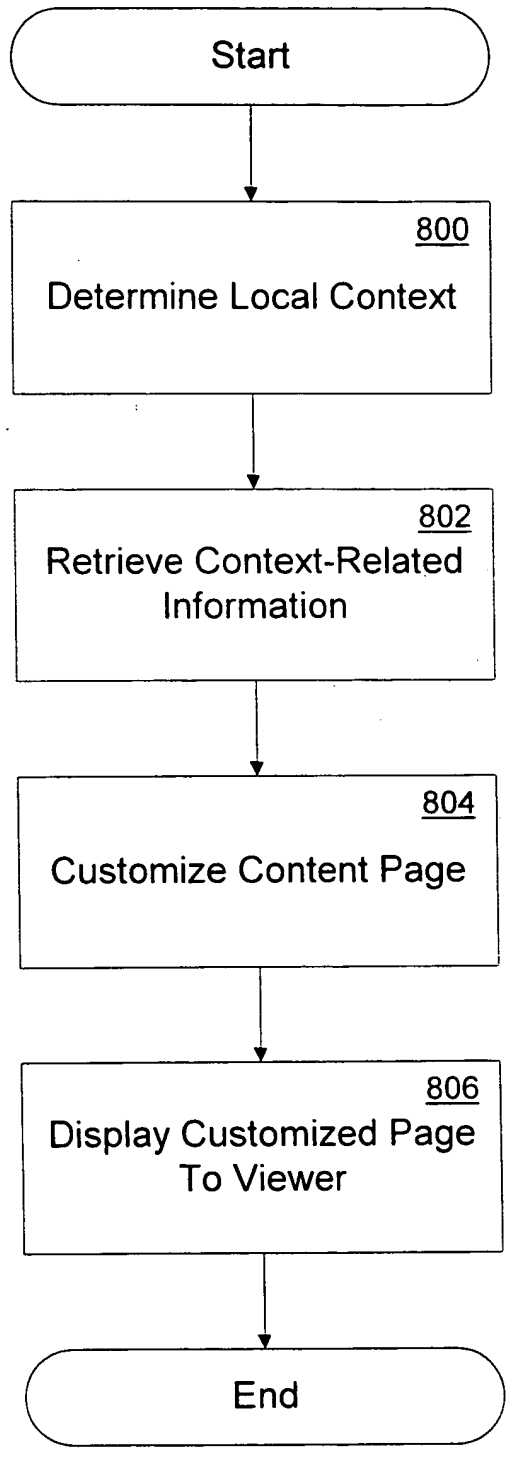

Fig. 8

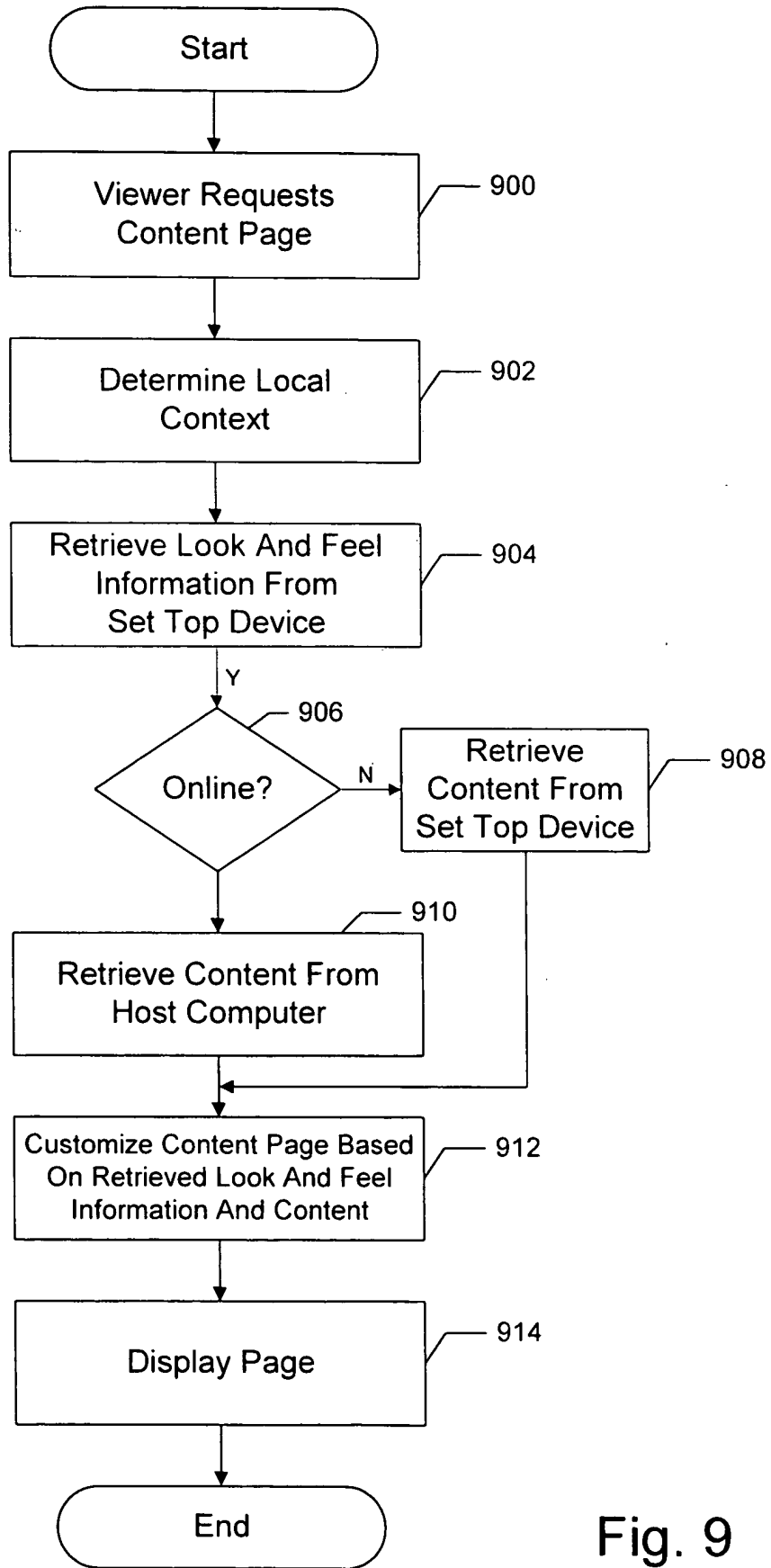

Fig. 9